

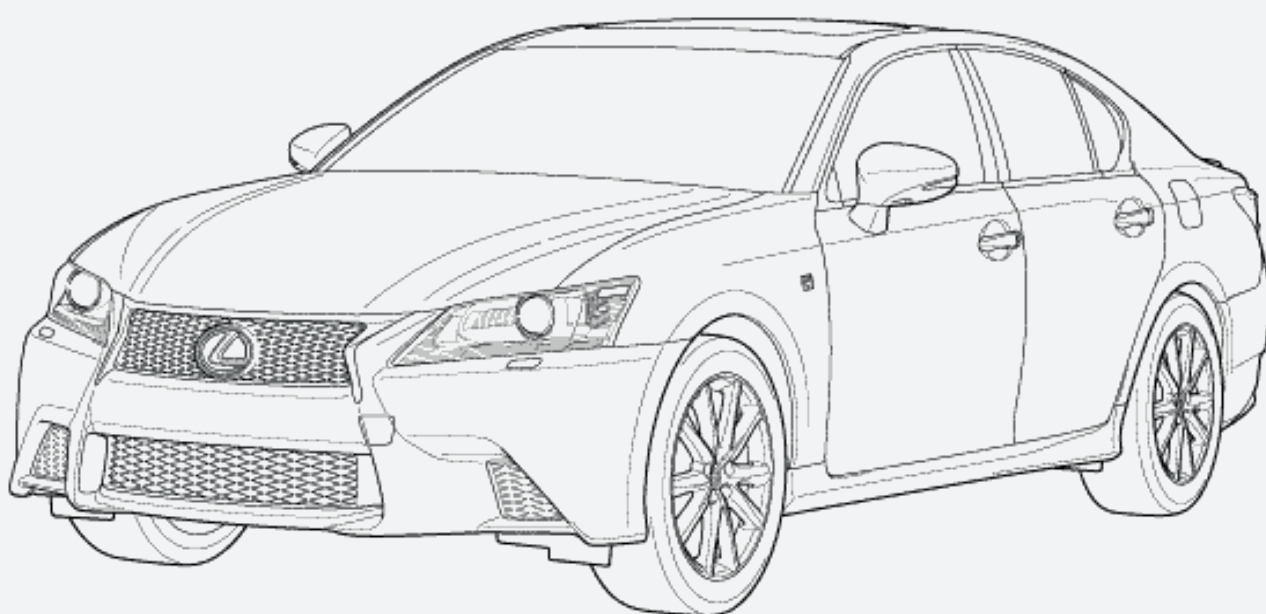

LEXUS GS F-SPORT

КОМПЛЕКТ ЗАЩИТНЫХ СЕТОК

Руководство по установке



Модельный год:	2012/01
Каталожный номер:	FRPRN-30020
Применимость:	Lexus GS F-Sport
 Вес:	0.3 кг
 Время установки:	120 мин



Электронная
версия инструкции
расположена на портале
tmr.pkplst.ru

FRPRN-30020

A

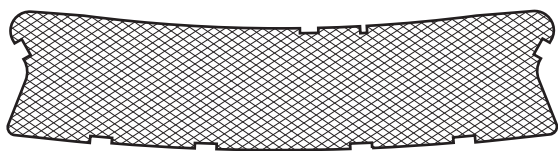

1x

C

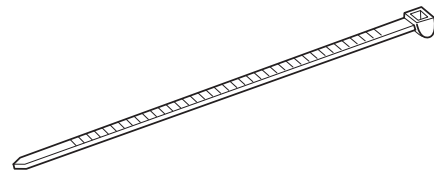

22x

B

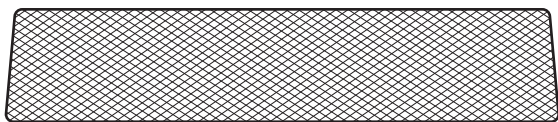

1x



1x

Используемый инструмент



Дрель



Сверло
Ø 3 мм



Бокорезы



Щипцы



Подставка
(козлы)



Внимание!

Снятие и установка бампера/решетки радиатора производится согласно руководству по ремонту автомобиля.

1

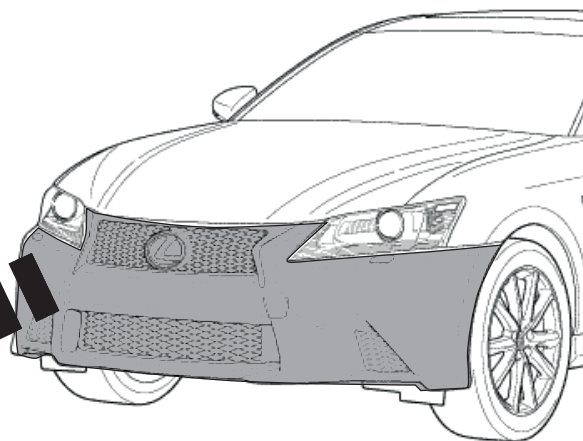
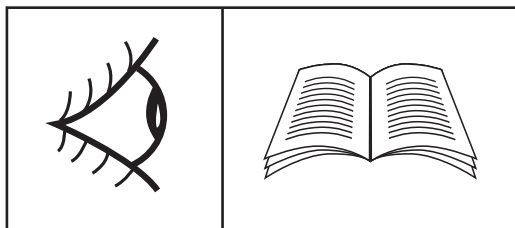

2

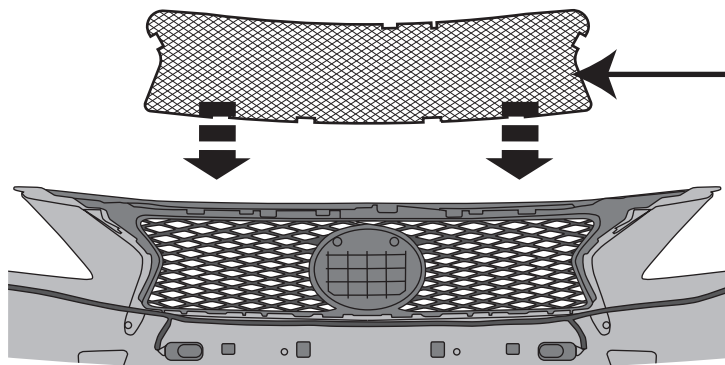

A



3

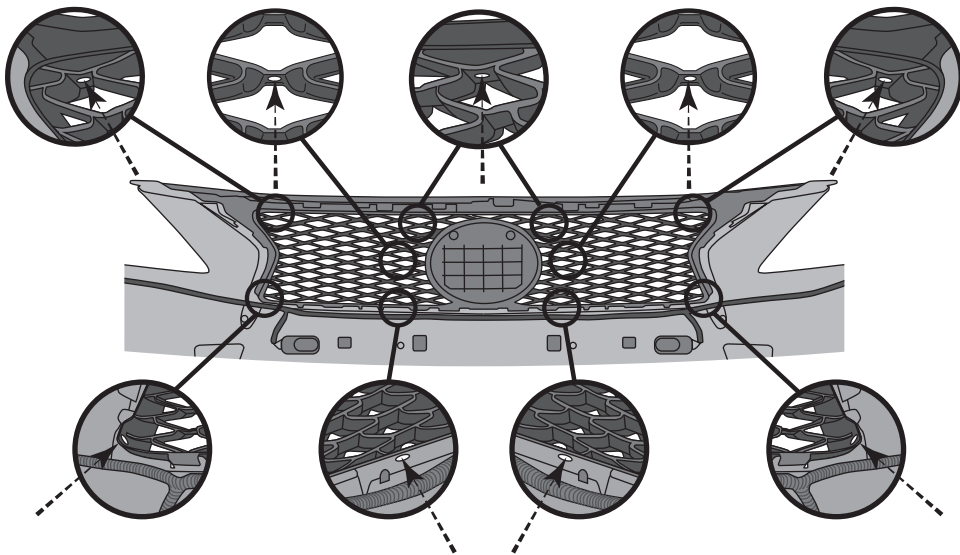

4

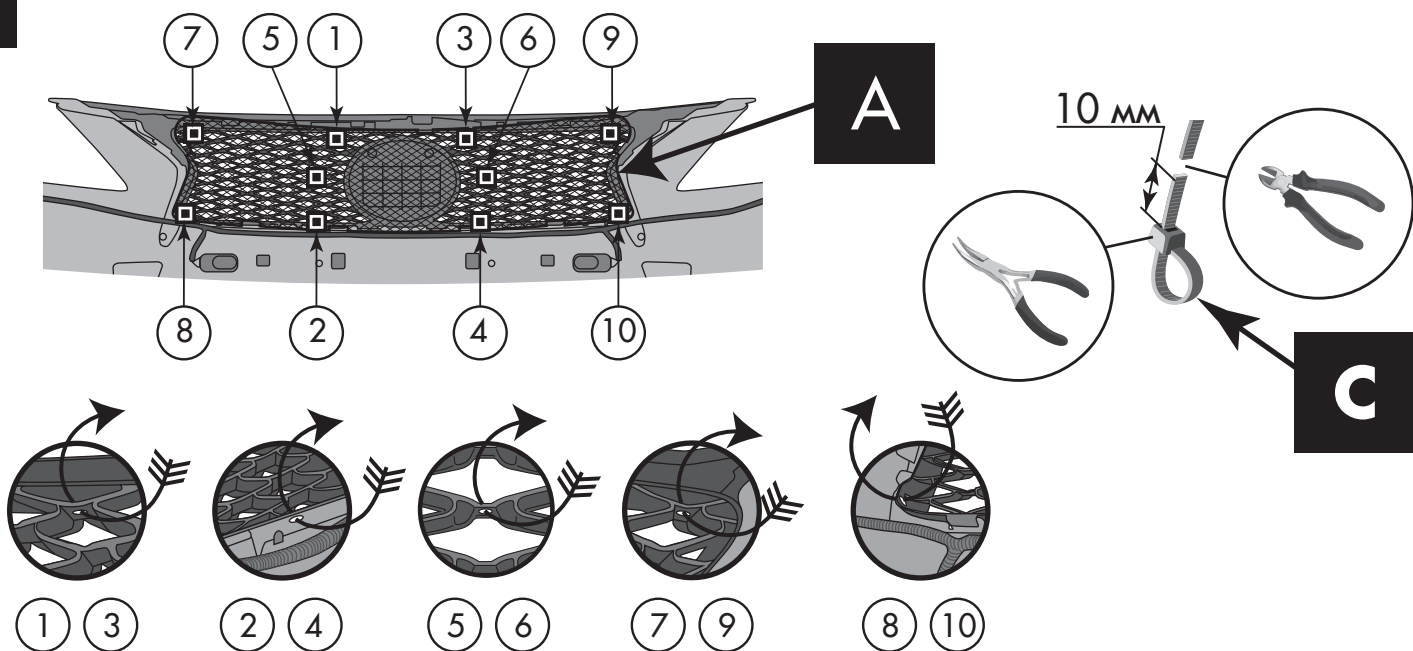

5

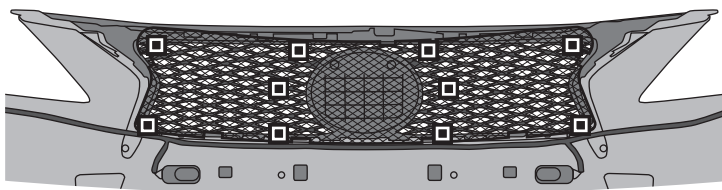

6

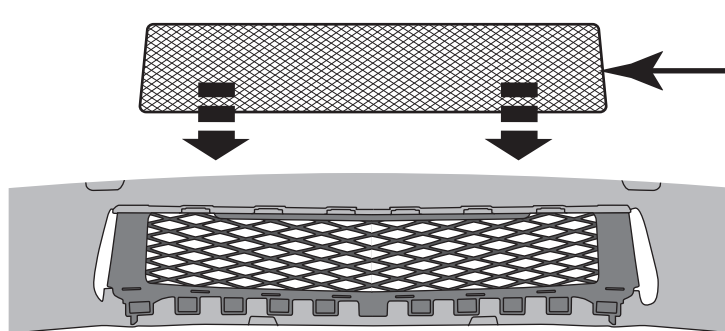

7

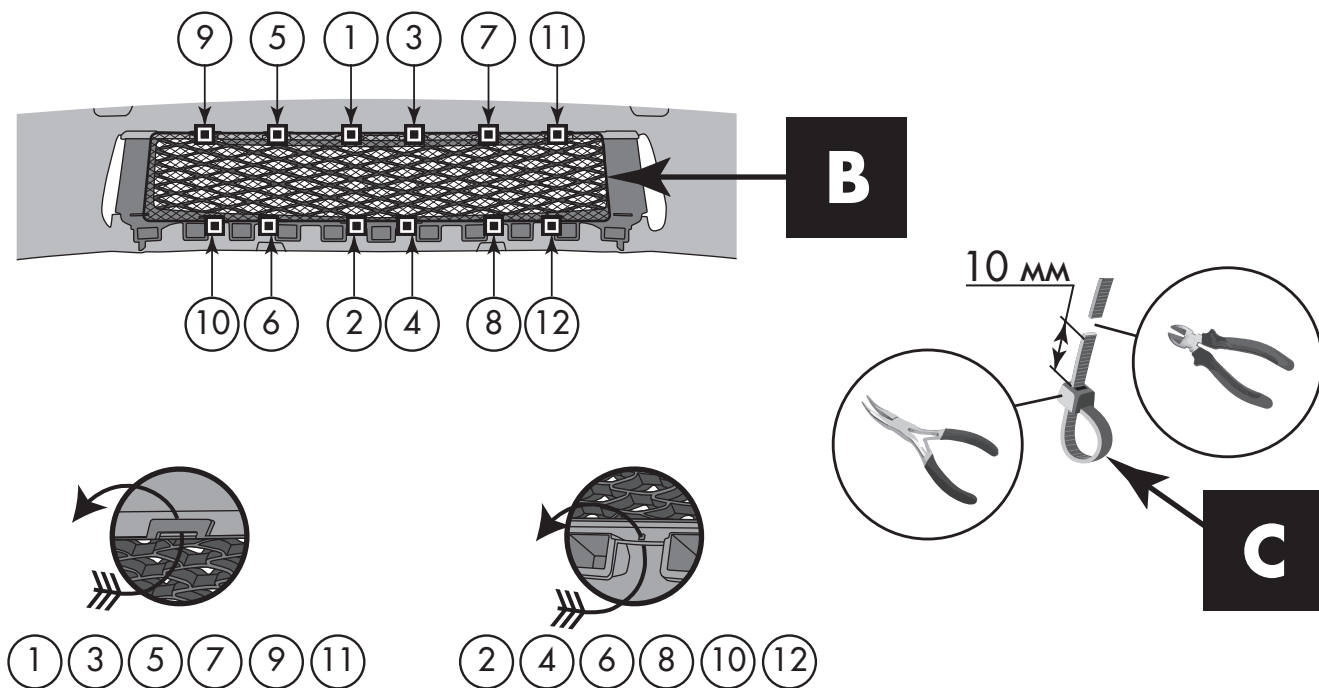

8

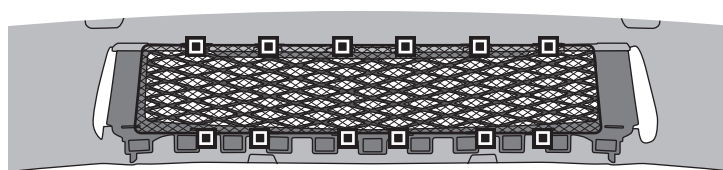

9

